

IMPORTANT: Prior to construction, check with your local or regional municipalities for building code requirements in your area.
IMPORTANT : Avant la construction, consultez votre municipalité locale ou régionale pour connaître les exigences du code du bâtiment dans votre région.
IMPORTANTE: Antes de la construcción, consulte con su municipalidad local o regional para informarse sobre los requisitos de los código de construcción en su área.

10



SQPS32 Square Baluster DECK RAIL Installation Instructions OPTION #2

Note: Contents of this package will cover an average of 4 linear feet (122 cm)

Instructions d'installation de la BALUSTRADE DE TERRASSE avec balustres carrés SQPS32 - OPTION N° 2

Remarque : Le contenu de cet emballage couvrira en moyenne 4 pieds linéaires (122 cm)

Instrucciones de instalación del PASAMANOS DE TERRAZA con balaustres cuadrados SQPS32 - OPCIÓN #2

Nota: El contenido de este paquete cubrirá un promedio de 4 pies lineales (122 cm)

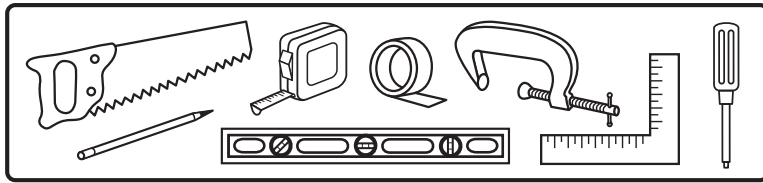

1

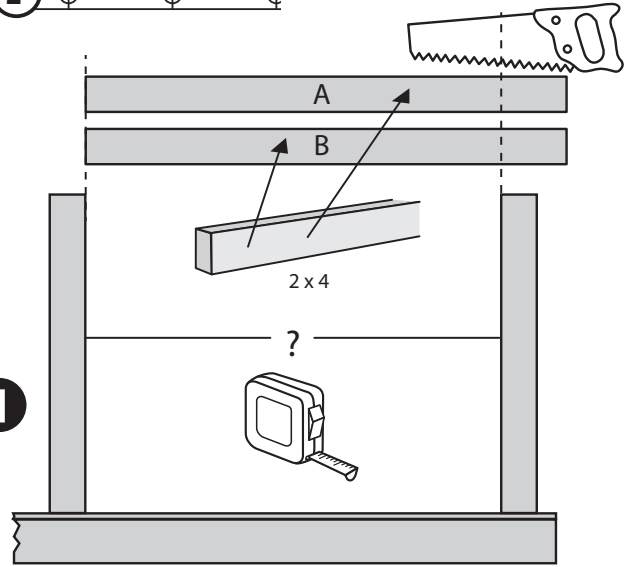

2

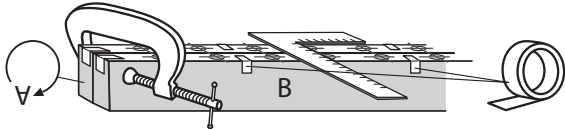

3

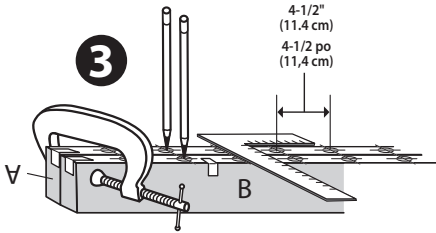

SMDRA*

4

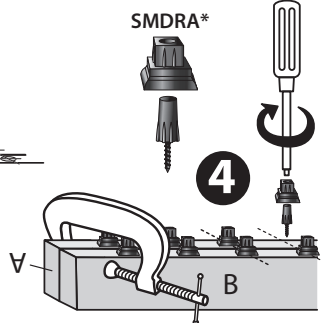

5

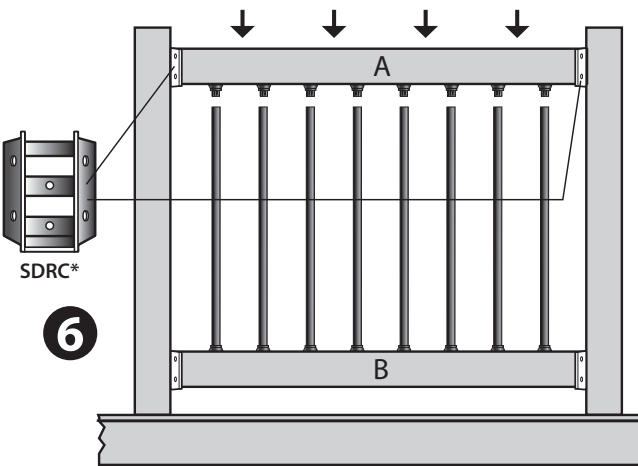
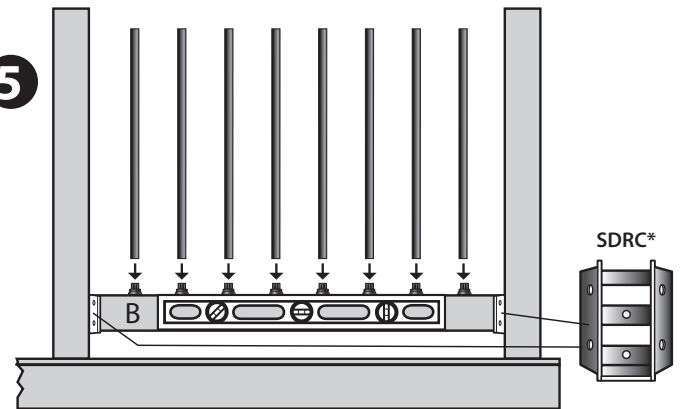

6

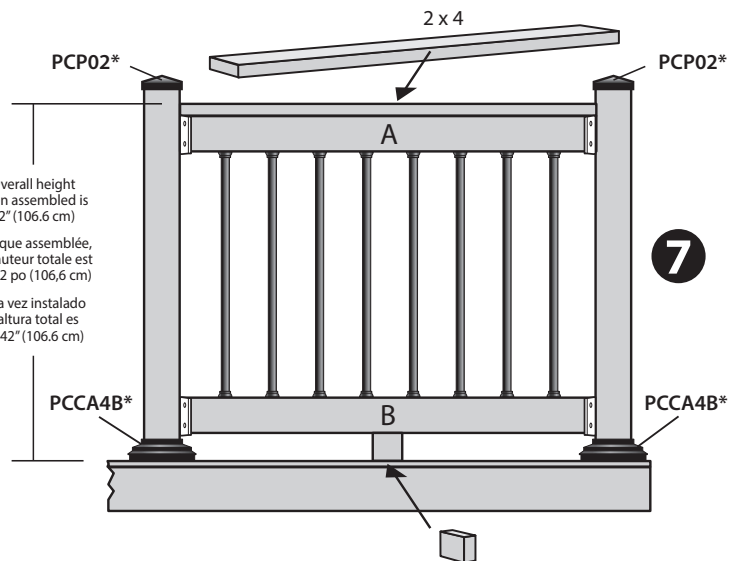

7

NOTE: * sold separately REMARQUE : * vendu séparément NOTA: * se vende por separado



NUVO IRON^{MC} 1-866-955-0355
www.nuvoiron.com

