

PARTS INCLUDED:

A TRAXX POST (1)

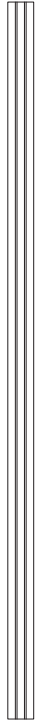

B POST CAP (1)

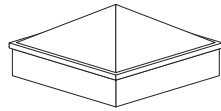

C SPACERS / BOARD LOCKS (10)

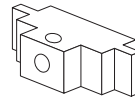

D SELF-TAPPING SCREWS (10)



SURFACE MOUNT CONVERSION KIT (TRAXX-CK) - SOLD SEPARATELY

(For more Traxx accessories, see page 5)

E POST BASE SKIRT (1)

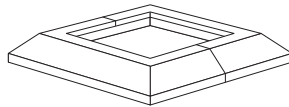

F SURFACE MOUNT PLATE (1)

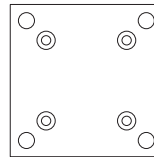

G ANCHOR BOLT (4)

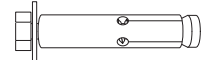

H SCREW (4)



I ALLEN KEY (1)



DECK BOARDS - SOLD SEPARATELY

Discover board options for your system available at Menards.
Choose from their unique selections:

AC2® 5/4 x 6 x 12' Above Ground Green Pressure Treated Thick Decking (SKU #111-0643):

Perfect for creating a stunning outdoor living area that withstands the elements and the test of time.

AC2® 5/4 x 6 x 12' Ground Contact CedarTone Premium Pressure Treated Thick Decking (SKU #111-6139):

Enhance your project with the rich CedarTone color and premium thickness, ideal for ground contact applications, ensuring longevity and style.

IMPORTANT:

If your installation site features a significant slope, read Step 4.

TOOLS REQUIRED:

- Safety Glasses
- Tape Measure
- String Line
- Post Hole Digger or Auger
- Concrete Mixer or Equipment to Mix Concrete
- Level
- Screwdriver or Drill with Allen Key Attachment
- Rubber Mallet
- Saw (if necessary)
- Masonry Drill Bit (1/2 inch) (if necessary)
- Wood Drill Bit (3/8 inch) (if necessary)
- Post Level

FOR A SUCCESSFUL INSTALLTION:

- Read the instructions completely before beginning the installation.
- Plan your project. Sketch your project with the actual measurements of your layout with the location of the posts.
- Check local building codes to ensure compliance.
- Check carton(s) to determine part count is complete.
- Installation is best accomplished with two people.
- Wear personal protection equipment; safety glasses, etc.
- Use care not to over-torque the screws.

IMPORTANT:

Please Note: before building a permanent structure, it is important to take into consideration where you live and your typical exposure to the seasonal elements as product performance may change accordingly. This includes, but is not limited to, rain, wind, snow, ice, sunlight, and intense heat. Wearing personal protective equipment; safety glasses, etc., and using suitable fasteners for your application are equally as important in ensuring your installation goes smoothly and safely.

Prior to installation, consult the appropriate professionals and/or authorities to ensure the avoidance of underground utilities.

Prior to construction, check with your local municipality for building code requirements in your area (consulting local building codes is required when supporting permanent structures).

For certain structures, we recommend consulting a professional to ensure that these products are appropriate for your intended application and that the structural components for which these products are to be used in connection with are sound.

In no event shall Nuvo Iron™ be liable for any consequential, special, or incidental changes arising out of breach of local, municipal, country, state, provincial, and federal building codes or any other type of laws or bylaws. Furthermore, Nuvo Iron™ shall not be held liable for any loss or damage resulting from improper use.

Nuvo Iron™, its advertising agency and delegates have made every effort to ensure the accuracy of all measurements and other details in these instructions and we anticipate no problems to arise. However, we cannot be responsible for errors beyond that effort. Therefore, always double-check details before beginning your project. Nuvo Iron™, its advertising agency and delegates shall not be held responsible for injury, damage or any other loss, however caused, resulting from the information contained in these instructions.

INSTALLATION INSTRUCTIONS:

Below we have suggested options that you can choose from to help guide your installation.

You can purchase 5/4" x 12' deck boards (Menards SKU #111-0643) to complete your project. 5/4" x 12' cedar tone deck boards (Menards SKU #111-6139) are available as well.

Option A - Without Spacers				Option B - With Spacers			
Approx. Height	Board Thickness	Boards Required	Post length in ground (cut remainder once assembled)	Approx. Height	Board Thickness	Boards Required	Post length in ground (cut remainder once assembled)
4' (48")	5/4"	9	32"	4' (48")	5/4"	8	32"
5' (60")	5/4"	11	32"	5' (60")	5/4"	10	32"
6' (72")	5/4"	13	32"	6' (72")	5/4"	12	32"

- When planning your Traxx Nuvo Iron™ fence project, make sure to map out your fence posts so they do not exceed 6' between your posts. This is the recommended distance between posts for our system.

Example for a 6' wide section: 73 1/2" is the center to center opening.

**These center to center dimensions will change depending on the width of your project.*

To determine the placement of the posts, plant two stakes at each end of the area where you want to install the structure. Use a stringline or guide, tie to each of the stakes creating a straight line connecting the two. Use this stringline as a guide to mark the precise positions where you want to dig each post hole.

Align the posts 1 1/2" closer than the total length of your chosen boards. This ensures that the boards can smoothly insert into the rail, accounting for the 3/4" insertion into the post.

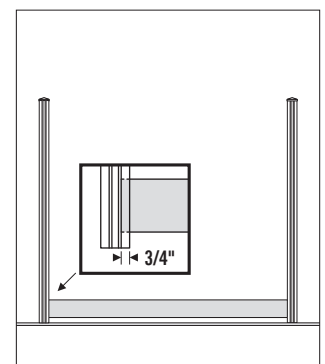

2. Dig post holes 8" in diameter, reaching a depth of 36" to 48", or deeper if required by the frost line in colder regions.

Add a 2" - 6" layer of gravel at the bottom to enhance drainage, particularly in areas with poor draining conditions.

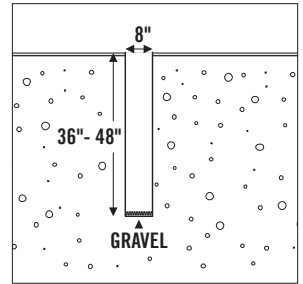

3. Place the Traxx post into the prepared hole. Depending on the grading of the ground, ensure it stands a minimum of 76" for level fence that's 6' tall.

In most cases, mixing your concrete to a semi-wet but slightly drier consistency works well to keep the post stable. But remember, it's best to check and follow your concrete manufacturer's guidelines first.

As an alternative stabilization method (Fig. 1), you can use a 2 x 4 braced with a clamp. Position one end of the 2 x 4 against the post and secure the other end with a grading stake driven into the ground to support the 2 x 4 as the concrete hardens.

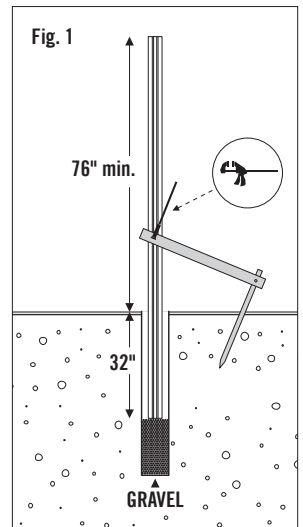

4. Proceed to fill the hole with concrete to secure the post in place. It's important to check local building regulations and consult the concrete supplier for any specific instructions relevant to this part of your fence installation.

While the concrete is setting, use a level to maintain the post's vertical alignment on both the X and Y axis, verifying that the distance from the ground to the post's top remains at least 76" for a 6' high fence. This step is crucial to avoid the need for post-adjustments after the fence installation is complete.

Repeat this same procedure for all posts in your fence project.

For Sloped Installation Adjustments:

If your installation site features a significant slope, it's crucial to stake and measure the full length and width of the fencing perimeter to ensure the elevation changes do not exceed 16 1/2" from lowest to highest if a maximum fence height of 76" is desired. (*adjust the 76" measurement to ensure your fence aligns properly across different elevations*).

Minimum depth of post in concrete is 15 1/2" see Fig. 2.

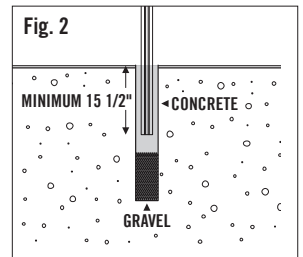
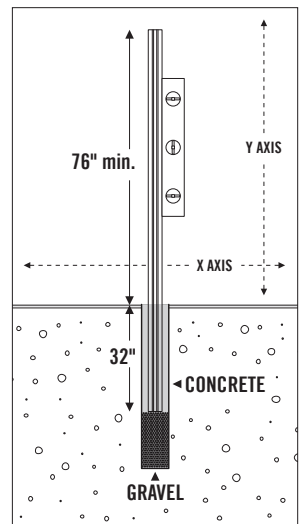
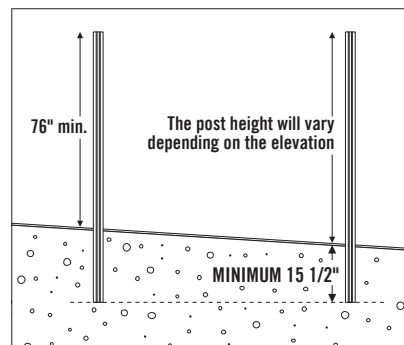

5. Now, depending on whether you are installing without spacers (**Option A**) or with spacers (**Option B**), the placement of your first spacer or board lock will vary. Refer to the chart to determine where to fasten this using the provided self-tapping screws.

See (Fig. 3) for a top view of where you will slide the spacer or board lock down from.

IMPORTANT: After installing the first board, ensure that it is completely level. The alignment of this board will set the baseline for all subsequent boards (Fig. 4).

OPTION A

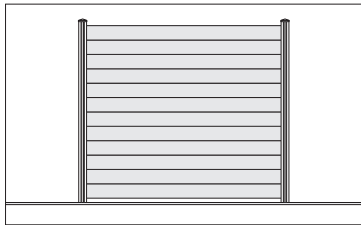

OPTION B

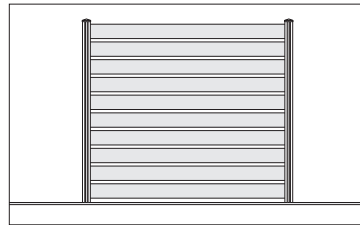

Fig. 3

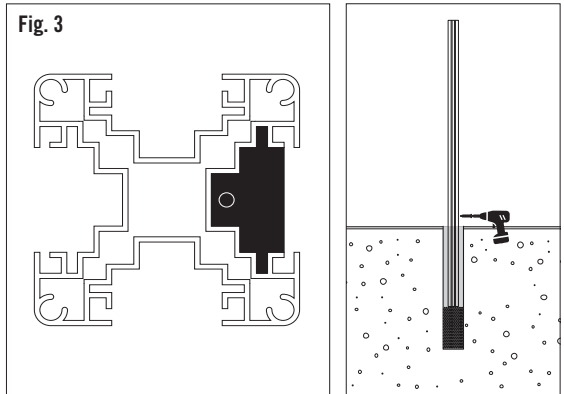
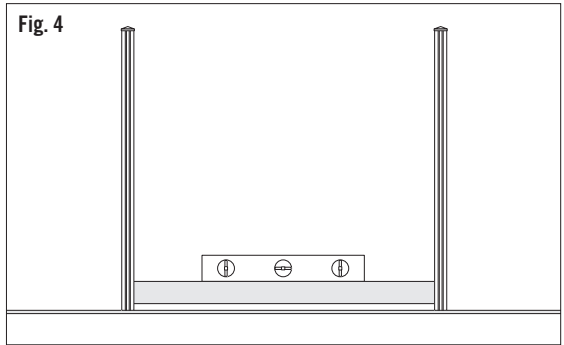

Fig. 4



For Sloped Installation Adjustments:

Follow these steps to adjust the board length for a sloped area:

Begin by aligning a board with your last fence section. Ensure it is level, even if it means the board will not be parallel to the slope (Fig. 5).

Attach a pencil to a scrap piece of wood, matching the width of your fence board. Slide this setup along the ground, maintaining contact, to transfer the slope's contour onto the fence board using the pencil (Fig. 6).

Carefully follow the pencil mark with a jigsaw to cut the fence board according to the slope's gradient.

Install the cut board into the designated post slots. Use a level to check the board's alignment, making adjustments as necessary to ensure it is perfectly horizontal (Fig. 7).

Fig. 5

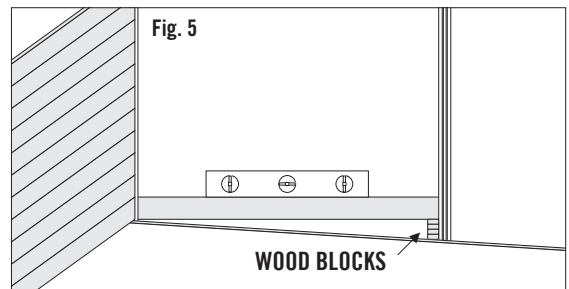

Fig. 6

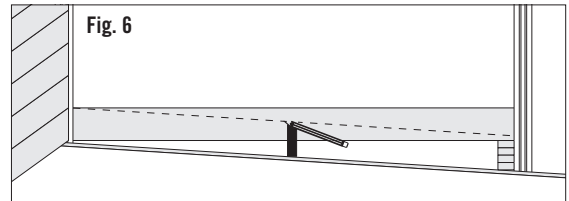
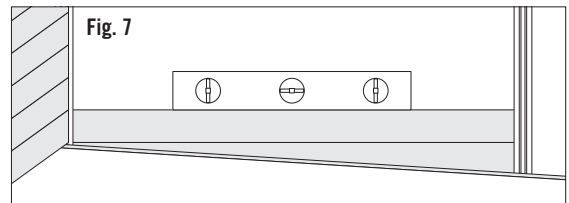

Fig. 7



6. **Note:** If you chose Option B you do not need to screw in the spacers that are in-between the boards, to the post.

Continue placing the boards into your post.

When you have positioned the final board at the top, secure the last spacer, which will function as a board lock into the post with a self-tapping screw. (Fig. 8). This step is crucial to ensure that the entire section of boards remains securely assembled.

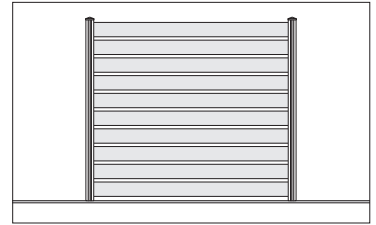
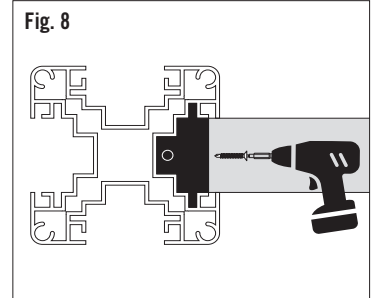
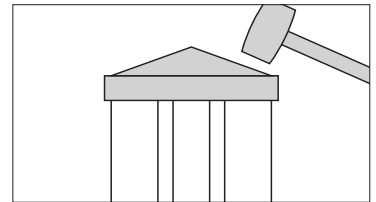

Fig. 8



7. Lastly, position the post cap on top of the post. Use a rubber mallet to firmly press it down onto the post. The post cap is designed to be secured through pressure fitting, so you will not need to use any screws or adhesives.



Traxx Horizontal Fence System Offers Two Stylish Finished Solutions

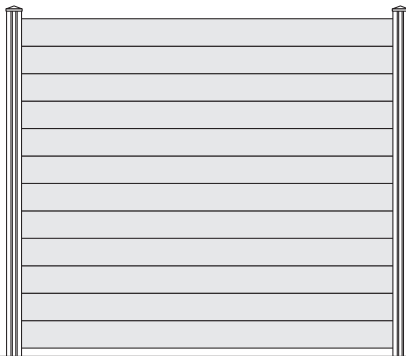

NO SPACERS



WITH SPACERS

SOLD SEPARATELY:

TRAXX-LN8

Pack of (8) Liners

These liners allow you to use various board sizes with our system, from 1" – 5/8" thick boards.

Follow the instructions until **Step 5**.

Then, before you begin inserting any boards, insert the rubber gaskets on both sides of the Traxx channel. The thicker part of the gasket should be closest the inside of the post, with the thinner part closer to the center opening.

Slide the liner down the entire length of the post on both sides, then continue to follow the instructions.

Continue the remainder of instructions from Step 5 onward.

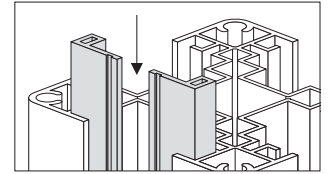

TRAXX-FS3

Pack of (3) 72" long filler strips

Used for creating a polished look on the sides of your Traxx system that boards have not been inserted into.

Complete your installation.

Once completed, slide your filler strips down any of the post openings for a polished look.

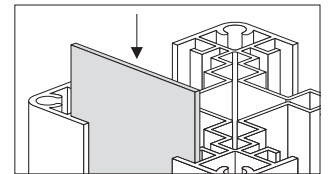

TRAXX-SP50

Pack of (50) spacers

Used for creating 1/2" gaps between boards for a unique slatted look to your fence project.

You can create wider gaps if desired by stacking multiple spacers. Follow the instructions for **Option B** for how to add spacers between your boards when building your Traxx project.

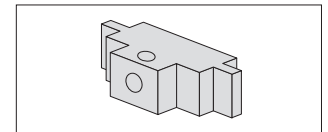

TRAXX-CK

For those who wish to anchor their post to a surface such as concrete, we offer our conversion kit for an effortless solution. Shims may be required to properly level or plumb post for proper installation.

Includes one post base, post base cover, and hardware.

Secure the plate to the bottom of the post using (4) of the flat head 5/16" screws (H) with the included Allen key (I).

Align the posts 1 1/2" closer than the total length of your chosen boards. This ensures that the boards can smoothly insert into the rail, accounting for the 3/4" insertion into the post.

Concrete: Mark and then drill holes with a 1/2" masonry bit before anchoring with the (4) provided concrete anchors (G).

Wood/Composite: Mark and then pre-drill with 1/4" bit and attach with, at minimum, (4) 1/2" x 3" long lag bolts (not included). Ensure you select the correct hardware for the materials you're attaching to, and consult your local building codes for requirements in your area.

